

ABCDEFGHIJKLMNQRSTUWXYZ 10 84

NORTH

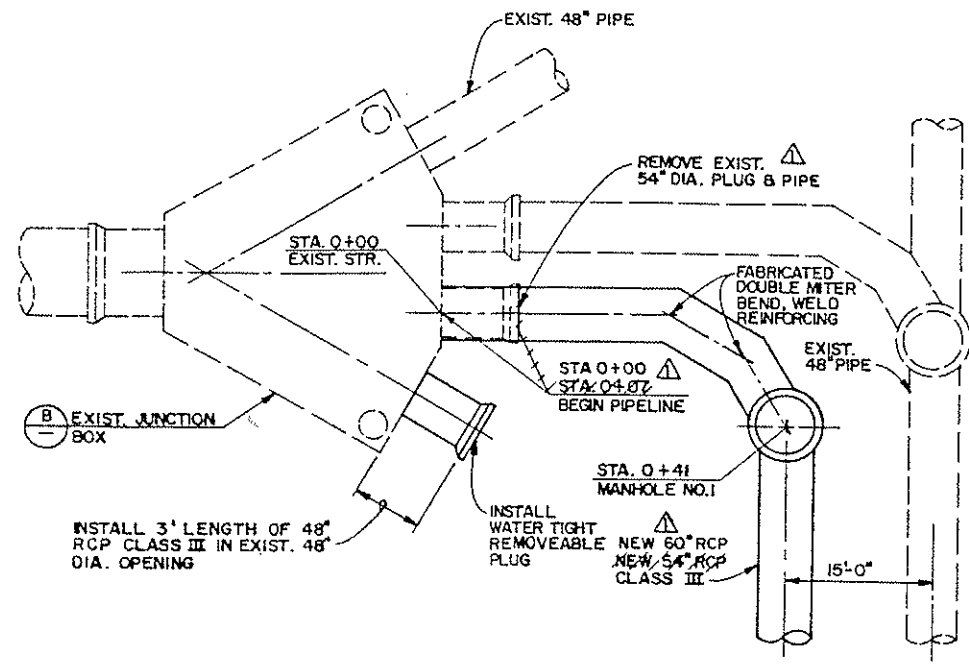

A JUNCTION BOX CONNECTION
SCALE: 1" = 10'

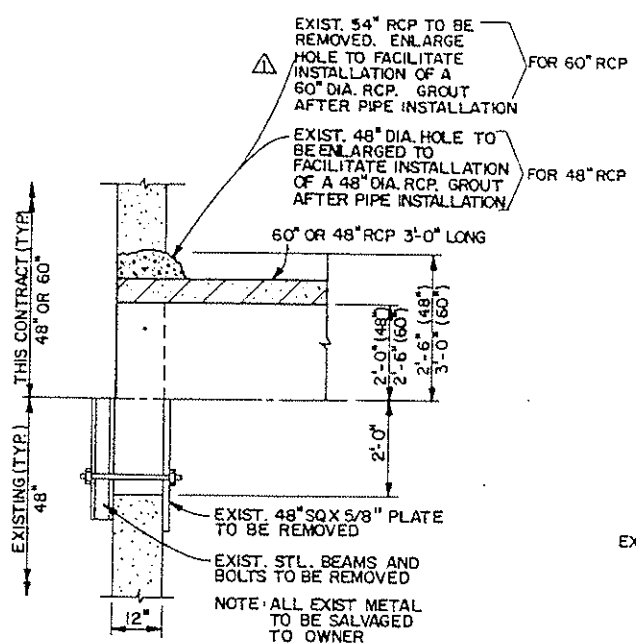

C SECTION
SCALE: 1/2" = 1'-0"

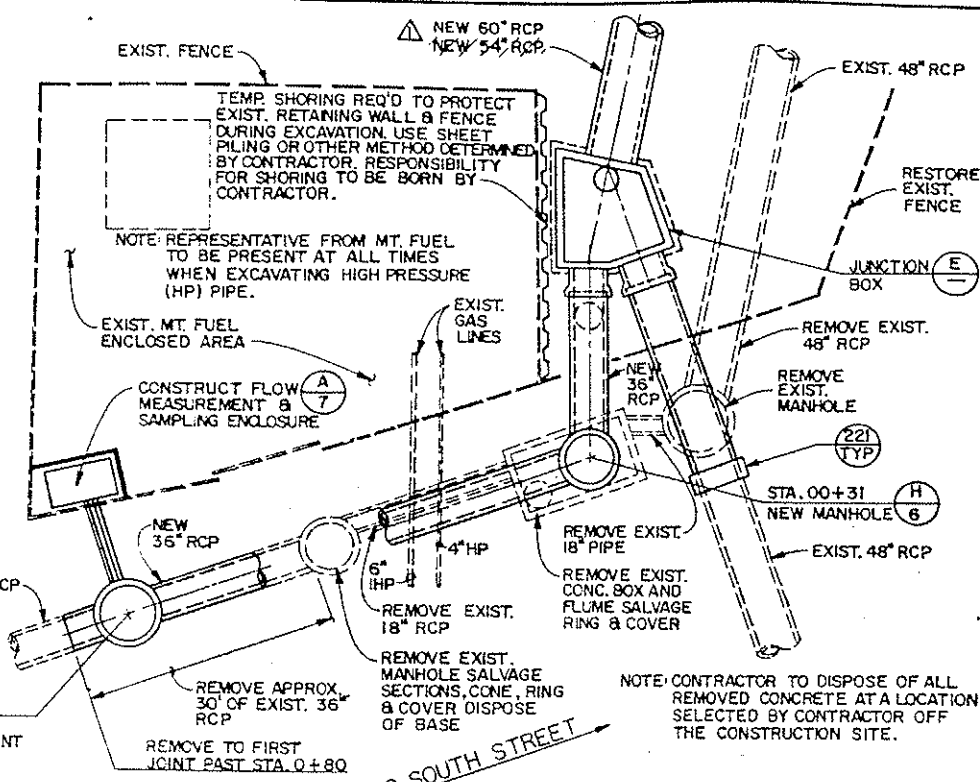

D DEMOLITION PLAN VIEW
SCALE: 1" = 10'

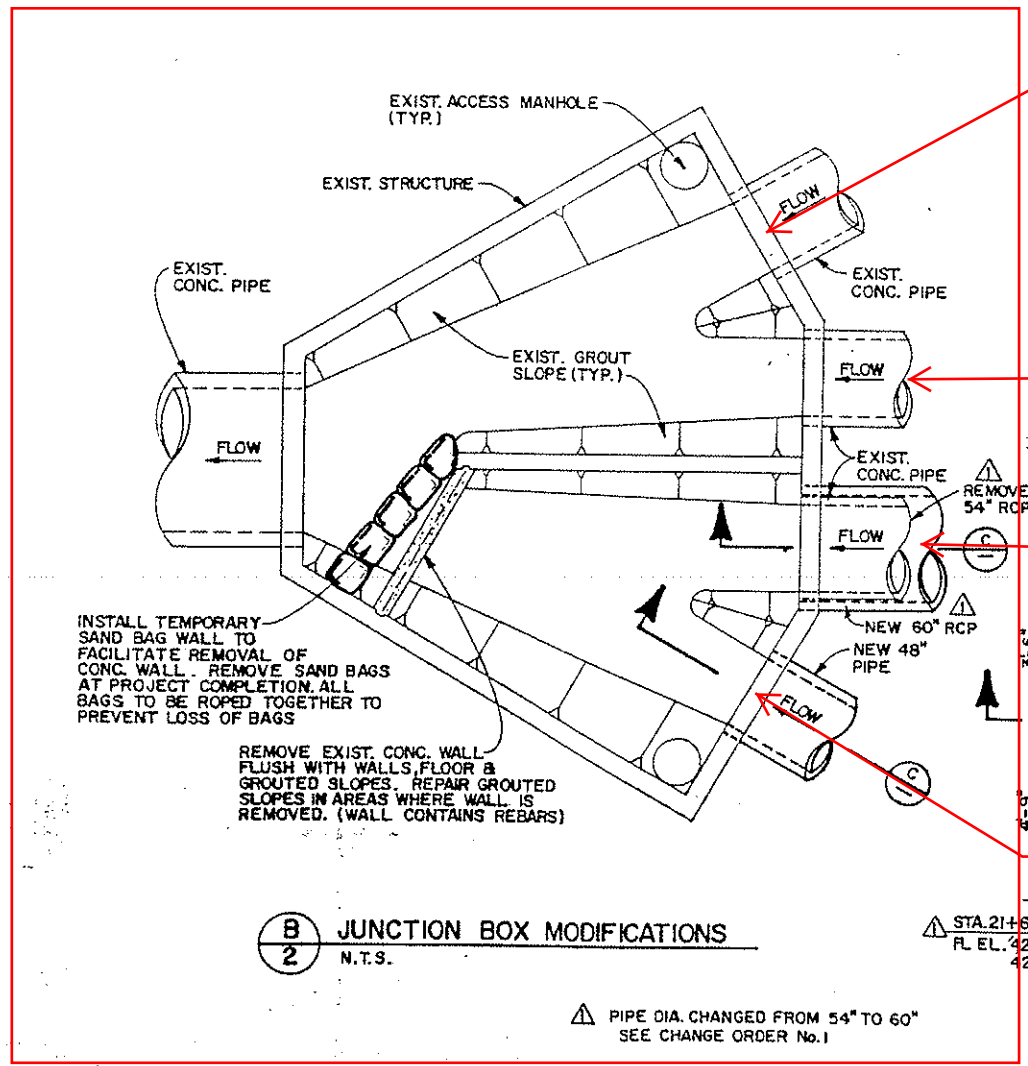

B JUNCTION BOX MODIFICATIONS
N.T.S.

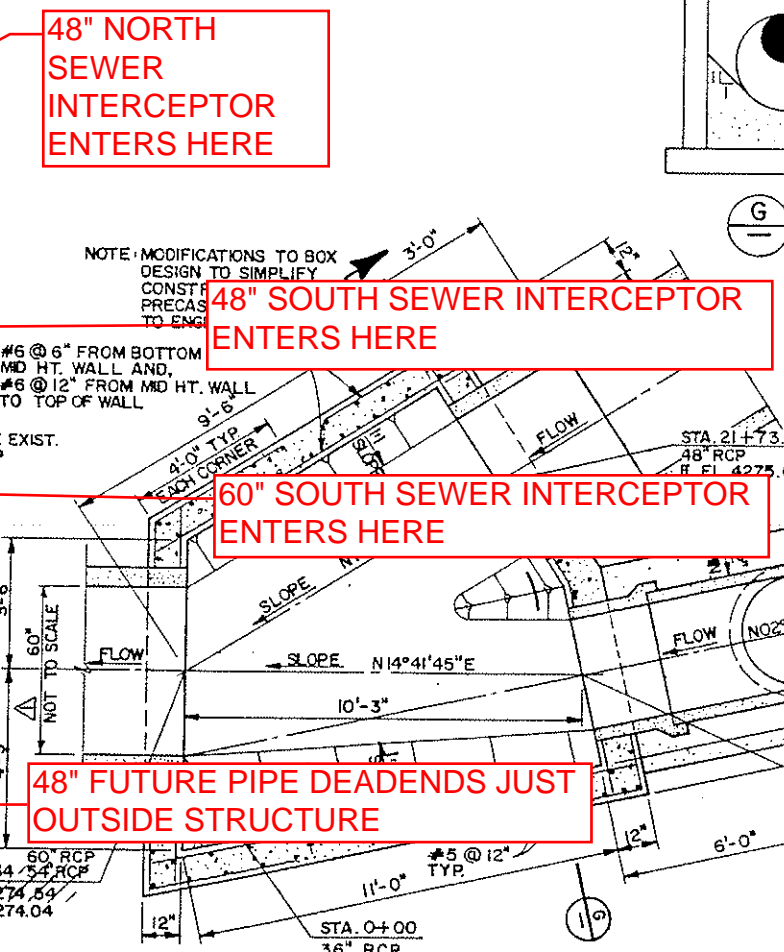

E JUNCTION BOX
SCALE: 3/8" = 1'-0"

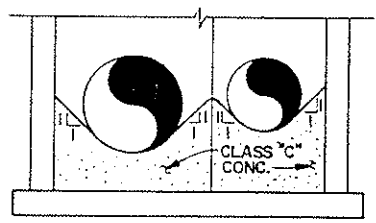

G SECTION
N.T.S.

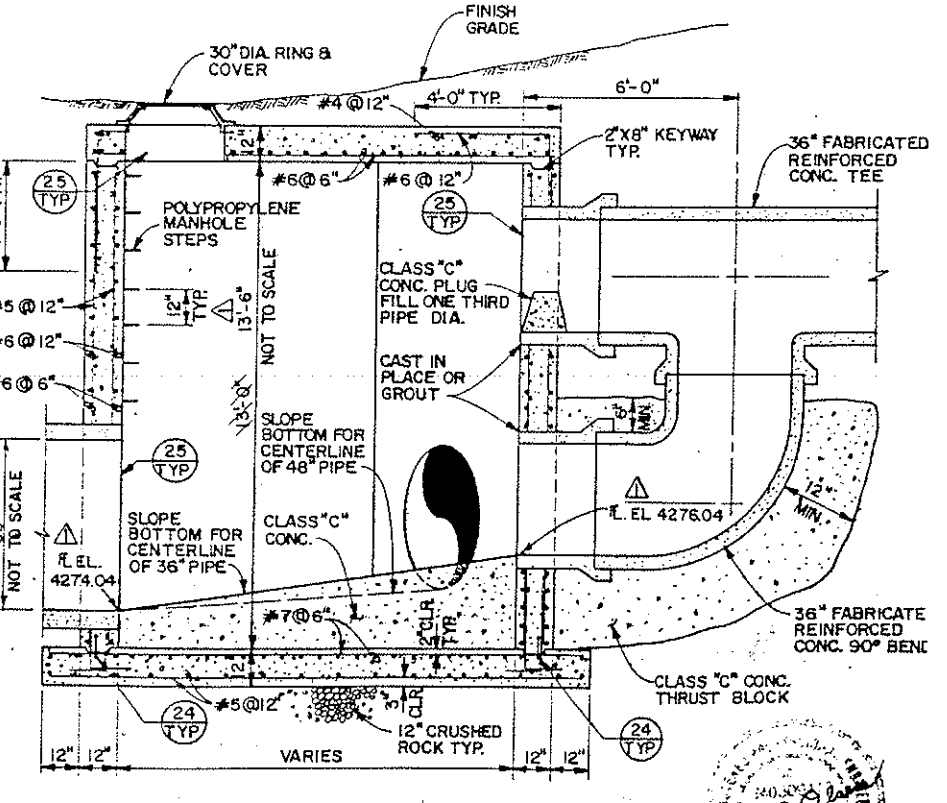

F SECTION
SCALE: 3/8" = 1'-0"

